

# Riegel

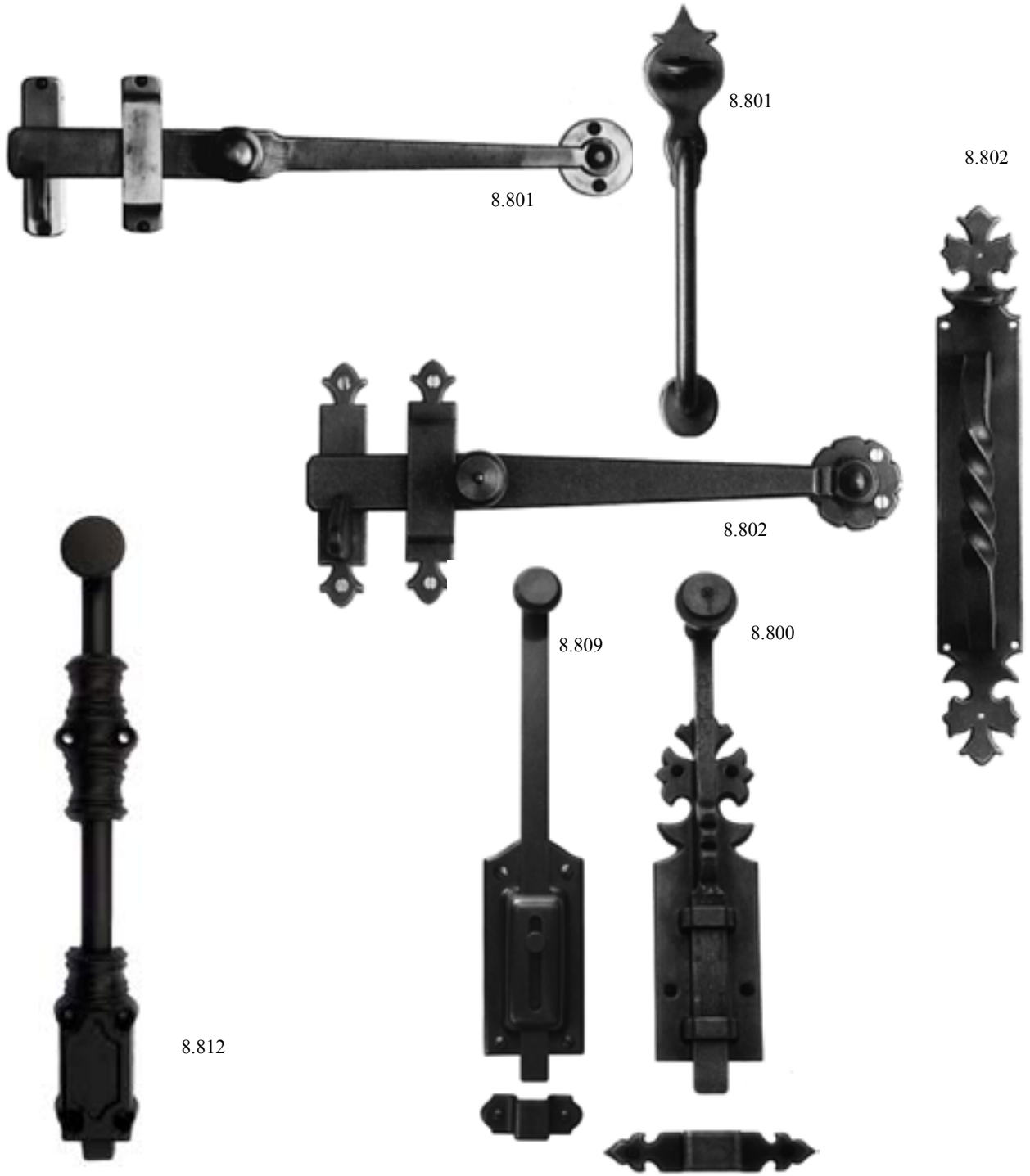

Artikel		Länge	Breite	Material	Bemerkung
Riegel	8.800	250/ 300/ 400 mm	50 mm	Fe, Fes	Hub: 30 mm
	8.809	250/ 300 mm	50 mm	Fe, Fes	Hub: 40 mm
	8.810	100 mm	40 mm	Ms	Hub: 15 mm
	8.812	max. 400 mm	43 mm	Fes	Hub: 20 mm
Fallriegel	8.801	310 mm		Fe	
	8.802	300 mm		Fes	



# Einreiber und Fensterkrücken

6.002



6.006



6.046



6.043



6.044



6.012



6.036



6.045

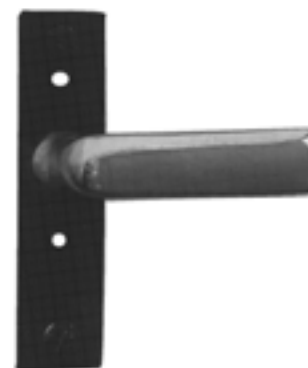

Maße Standardplatte: 20 x 65 mm  
Maße Schließblech: 16/ 20 mm x 74 mm

Artikel		Länge	Material	Bemerkungen
Vorreiber	6.006	50 mm	Ms, Fe	
Fensterkrücke	6.012	70 mm	Ms	auch als Halb-olive
	6.036	62 mm	Ms, Fe	
	6.043	77 mm	Ms	
	6.044	50 mm		
	6.046	66 mm		
	Einreiber	6.045		56 mm
6.002		55 mm		

Distanz Platte- Zunge, Zarge auf Achse oder 90° rechts oder links angeben.

## Tummescheit

# Einreiber und Fensterkrücken



6.052



5.064



4.072

3.169



6.007



6.051



6.005



6.007

Maße Standardplatte: 20 x 65 mm  
 Maße Schließblech: 16/ 20 mm x 74 mm

Artikel	Länge	Breite	Material	Sonderausführungen	
Einreiber oder Krücken	6.052	70 mm	Ms	Zunge 90° rechts o. links bzw. auf Griff- achse	
	6.007	57 mm	Ms/Fe		
	6.005	53 mm			
	6.051	68 mm	Ms/Fe		
Olive	3.169	44 mm	Ms	f. Einreiberschließchen	
Knopf	5.064	49 mm	33 mm	Ms	
Rosette	4.072	58 mm		Ms	

Distanz Platte- Zunge, Zarge auf Achse oder 90° rechts oder links angeben.

Streichdraht  
Distanzstücke nach Erfordernis

Artikel	Länge	Material	Artikel	Länge	Material	Bemerkungen	
Vorreiber	6.000	97 mm	Tg, Ms	6.021	55 mm	Tg/ Ms	
	6.001	53 mm		6.022	60 mm		
	6.010	88 mm	Ms	6.023	85 mm	1-flügelig wie 6.010	
	6.014	80 mm		6.025	42 mm		
	6.015	57 mm	Tg	6.026	105 mm	Tg/ Ms	
	6.017	40 mm		6.041	95 mm	Fe / Ms	
	6.018	48 mm		6.042	52 mm		
	6.019	56 mm		6.047	85 mm		
	6.024	100 mm		6.049	46 mm	Ms	1-flügelig wie 6.023
				6.131	105 mm		

# Ankettel und Sturmhaken



	Artikel	Länge	Material	
Ankettel	6.200	57 mm	Ms, Tg	
	6.201	40 mm		
	6.202	55 mm	Fe, Ms	
	6.206	75 mm	Ms	
	6.224	75 mm	Fe	
Stützkloben	6.203		Fe, Ms	inkl. Stützkloben
	6.208		FeZi	
Ankettelhaken	6.205		FeZi	
Sturmhaken	6.300	125 mm	Tg, Ms	
	6.301	135 mm	Ms, Fe	

# Fensterstellstangen

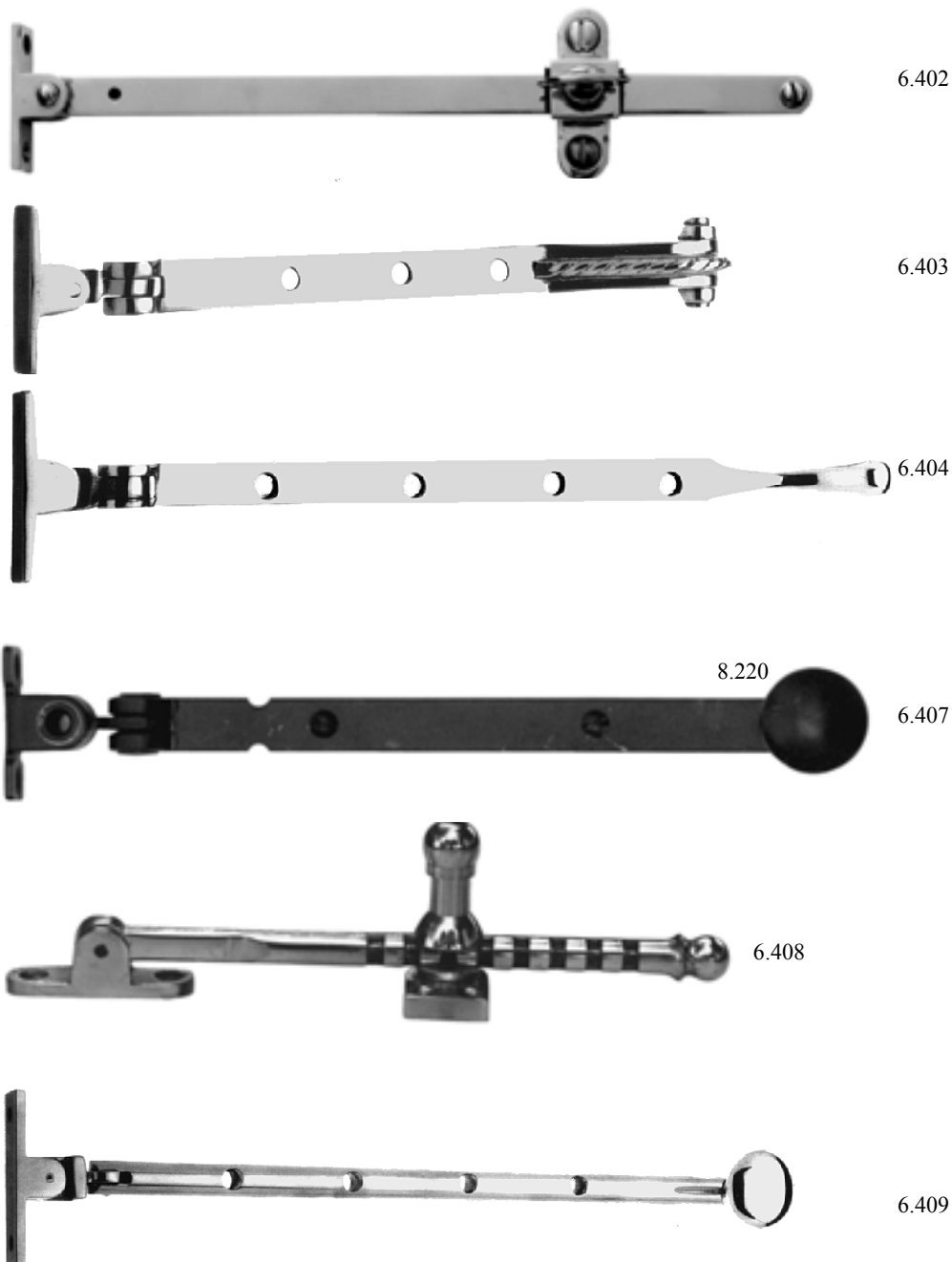

Artikel	Länge	Material	Bemerkungen
Feststeller	6.402	160 mm bis ... mm	inkl. 2 Kloben zum einhaken und schließen
	6.403	180 mm	
	6.404	260 mm	
	6.408	160 mm	
	6.409	160 mm bis ... mm	inkl. 2 Kloben zum einhaken und schließen
	6.407	220 / 320 mm	
Knopf	8.220	Fe, Msp	

# Beschläge für Oberlichter



Artikel		Länge/ Maße Grundplatte	Material	Bemerkungen
Oberlichtschnäpper	6.414	50x36 mm	Msp	
	6.415	67x38 / 52x30 mm		
Oberlichtscheren	6.416	100 / 150 / 200 mm	Msp, Alu	links und rechts verwendbar
Oberlichtöffner	6.417	140 / 180 / 220 mm	Msp	
		180 mm	Fe schwarz lackiert	
Stockhaken	6.418		Msp, Fe	

# Klingelknöpfe

6.500



6.501



6.502



6.503



Auch mit anderen Rosetten herstellbar

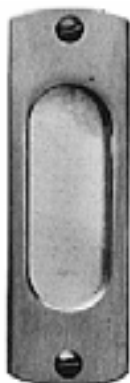

6.600



6.607



6.609



6.612



6.613

Türsprechanlage Messing in Sonderanfertigung

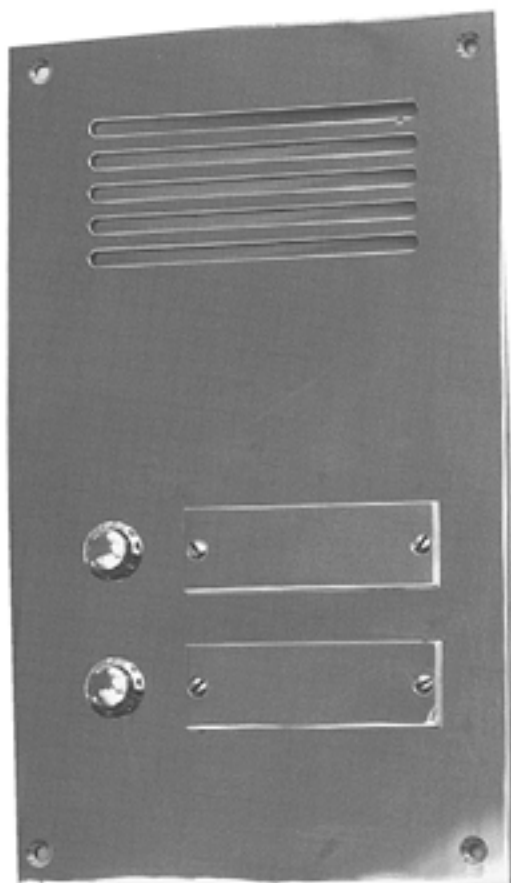

6.608



6.601

Artikel		Länge / Ø	Breite	Material
Klingelknopf	6.500	75 mm	75 mm	Ms
	6.501	80 mm	34 mm	
	6.502	Ø 65 mm		
	6.503	Ø 65 mm		
Schiebetürmuscheln	6.600	110 mm	35 mm	Ms MsNi MsNim
	6.601	Ø 65 mm		
	6.607	117 mm	38 mm	
	6.608	55 mm	125 mm	
	6.609	100 mm	25 mm	
	6.612	142 mm	55 mm	
6.613	148 mm	50 mm		

# Sonstige



8.282



8.283



8.284



8.285



6.452



6.453



6.454



6.455

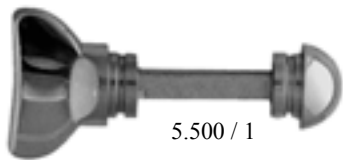

5.500 / 1

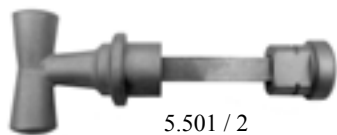

5.501 / 2

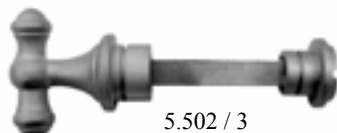

5.502 / 3



5.503 / 1



/ 1



/ 2



/ 3

Artikel		Länge / Ø	Material	Bemerkungen
Fensterknöpfe	8.282	25 / 30 mm	Ms, MsNi, MsNim Fe, FeZi FeZn	
	8.283	25 / 30 mm		
	8.284	25 / 30 mm		
	8.285	25 / 30 mm		
Fensterabhalter	6.453	85 mm	Ms, MsNi, MsNim FeZi	
	6.454	75 mm		
	6.455	115 mm		
Fensterkupplung	6.452		Ms, MsNi, MsNim	links und rechts
WC-Verriegelung	5.500			
	5.501			
	5.502			
	5.503			